

SECTION A-A

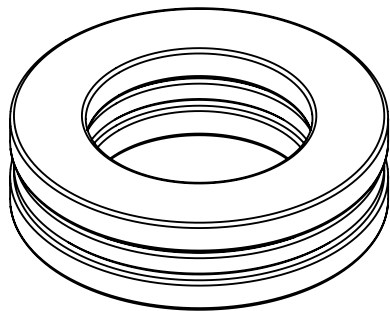
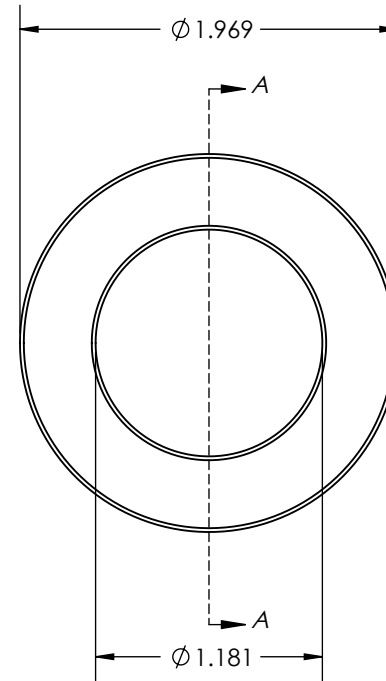

Auburn Bearing
 & MANUFACTURING
Made in the USA since 1898

DESCRIPTION
 Ball Thrust Bearing 1.181(30) x 1.969(50) x 0.551(14)

ITEM NUMBER
2906-ABB

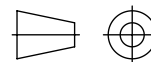

THE INFORMATION CONTAINED IN THIS DRAWING IS THE SOLE PROPERTY OF AUBURN BALL BEARING. ANY REPRODUCTION IN WHOLE OR IN PART WITHOUT THE WRITTEN PERMISSION OF AUBURN BALL BEARING IS PROHIBITED.