

SECTION A-A

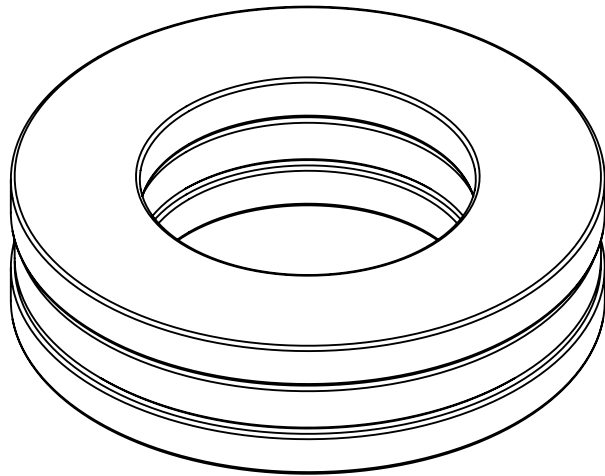
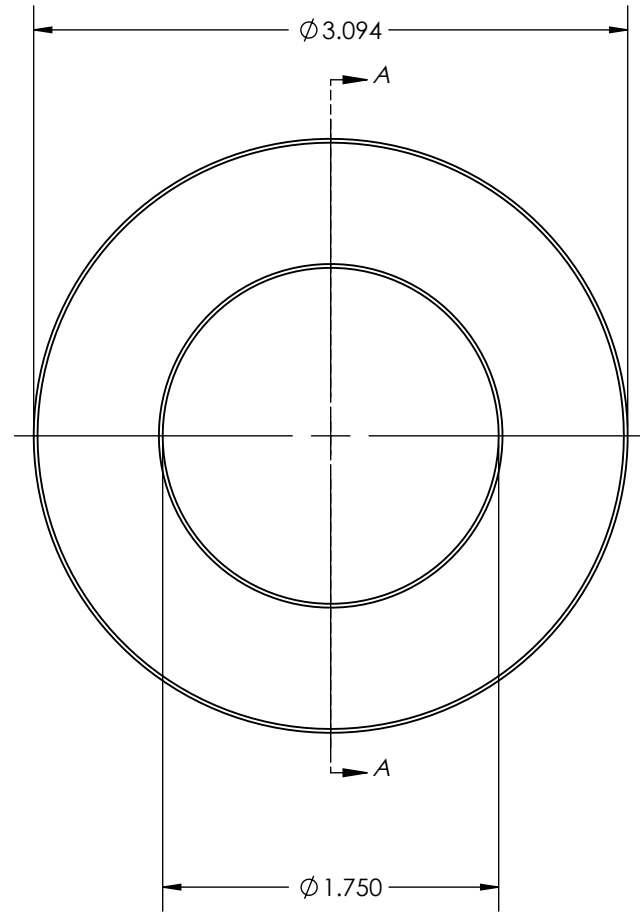

Auburn Bearing
& MANUFACTURING
Made in the USA since 1898

DESCRIPTION Roller Thrust Bearing, AE-32, 1.750 x 3.094 x .812

ITEM NUMBER

AE-32

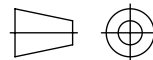

THE INFORMATION CONTAINED IN THIS DRAWING IS THE SOLE PROPERTY OF AUBURN BALL BEARING. ANY REPRODUCTION IN WHOLE OR IN PART WITHOUT THE WRITTEN PERMISSION OF AUBURN BALL BEARING IS PROHIBITED.