

SECTION A-A

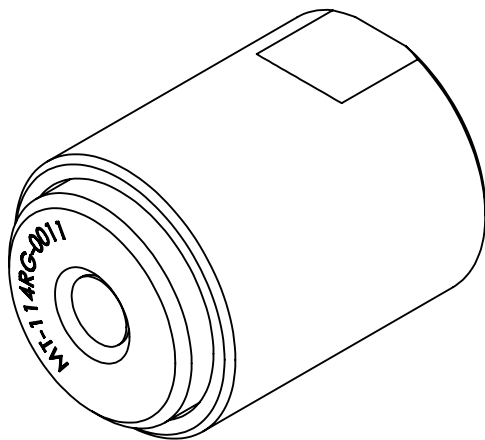
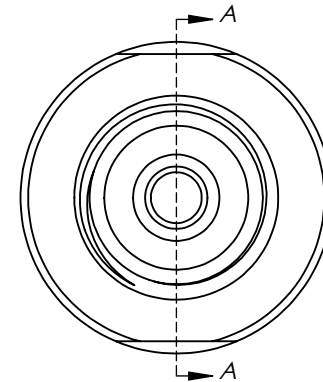

**Auburn Bearing**  
 & MANUFACTURING  
*Made in the USA since 1898*

DESCRIPTION

Thrust Bearing Mounted Assembly

ITEM NUMBER

**MT-114RG-0011**



THE INFORMATION CONTAINED IN THIS DRAWING IS THE SOLE PROPERTY OF AUBURN BALL BEARING. ANY REPRODUCTION IN WHOLE OR IN PART WITHOUT THE WRITTEN PERMISSION OF AUBURN BALL BEARING IS PROHIBITED.